

HOME VENTILATION SYSTEMS



SYN1015AD
SYN2025AD
SYN3035AD

User Manual

Your guide to a healthier home



Warning

- This appliance is not intended for use by persons (including children) with reduced physical, sensory or mental capabilities, or lack of experience and knowledge, unless they have been given supervision or instruction concerning use of the appliance by a person responsible for their safety.
- Children should be supervised to ensure that they do not play with the appliance.
- Isolate the mains supply before attempting to replace the system's air filter.

SMARTVENT SYNERGY3 SYSTEM

Contents

How the System Works	4
App Control and WiFi Connect	5
Quick Setup Guide	6
Screens and Navigation	9
Standby Screen	11
Home Screen	11
Home Screen Icons	12
Settings	14
Time-Date	15
Filter	16
General Settings.....	17
Settings Interface.....	19
Ventilation.....	20
Heat Transfer.....	23
Tempering Heater	26
Recycle	39
Maintenance.....	30
Filters	30
Recovery Core.....	32
Replace Sensor Battery.....	33
Troubleshooting.....	34
Error Codes.....	37
Glossary	38
Technical Specifications.....	39

How the System Works

Some features covered in this instruction manual are only available when installed and activated. Consult your installer for more information if you are interested in adding additional features to your system.

The SmartVent Synergy3 System



SmartVent Synergy3 is a heat/energy recovery ventilation system which uses air taken from the outside to ventilate your home.

System Enhancements¹⁾



Second Air Source

Adds air from the roof cavity as a second air source option so that your system can provide continued quality ventilation when the outside air is too cold or humid.



Heat Transfer

Used to transfer any excess heat from your lounge to your bedrooms.



Tempering Heaters

Designed for situations where supply air temperatures are too cool.

When system enhancements are added, your system can offer greater options in how it operates.

The options can override or influence one another as in the following examples.

Example: When the environment in your home meets your chosen heat transfer condition the ventilation and tempering heater functions deactivate.

Example: When the system is ventilating and conditions are met for the heater to turn on, the speed of the fan will be influenced by the heater function.

1) For more information about SmartVent system enhancements, contact 0800 140 150 or email enquiry@smartvent.co.nz

App Control and WiFi Connect

1. Install the Smart Life App.

Method 1: Download the Smart Life App from the App Store mobile App Store.

Method 2: Scan the QR code to download Smart Life App



2. Open Smart Life App, tap the  button to “Add Device”, then tap the scan button on the top right corner.



3. Put system into Wi-Fi pairing mode by turning the Touch Screen off and on **3 times (allow at least 2 second between button presses)**.

When prompted by the App to choose “Blink Quickly” or “Blink Slowly” choose the corresponding one according to the flashing blue leaf icon in the house.

Blink Quickly = 2 seconds on, 2 seconds off cycle

Blink Slowly = 4 seconds on, 2 seconds off cycle

Follow the prompt on the App to proceed. Once pairing is successful the leaf icon will turn Green for **5 seconds** before disappearing.

Pairing mode can be exited by either turning the touch screen off, successful pairing, or waiting 3 minutes.



If pairing with Blink Quickly does not succeed try Blink Slowly by turning the touch screen off and on 3 times again.

Quick Setup Guide

1 - Switch On

- Power on by pressing POWER .



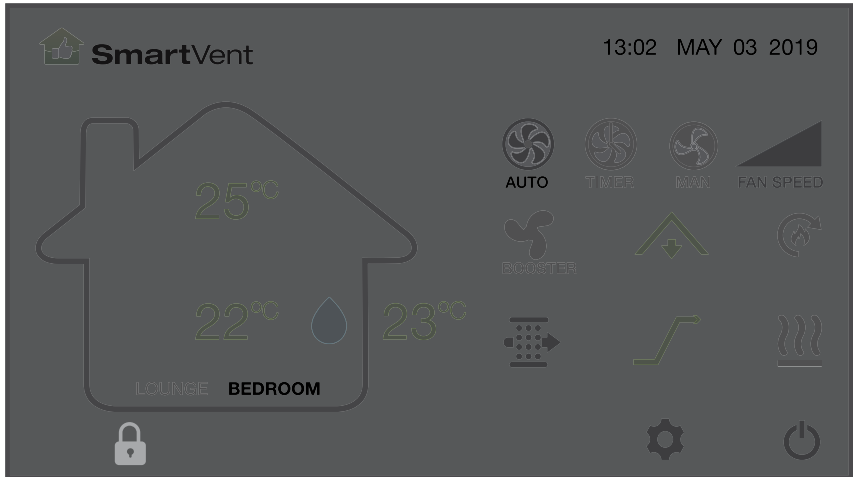

2 - Unlock the Touch Screen

- Hold down LOCK  for 5 seconds in the bottom left corner of the screen to unlock .



Quick Setup Guide

3 - Set the Clock



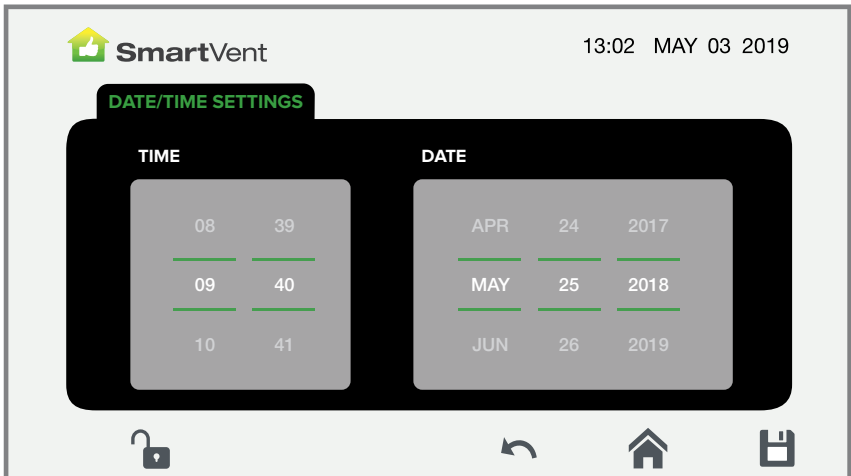

- Press **SETTINGS**  on the home screen.
- Select the **TIME-DATE** icon .
- Scroll and select the current time and time.
- Press **SAVE**  to save your changes.
- Press **HOME**  to return to the home screen.

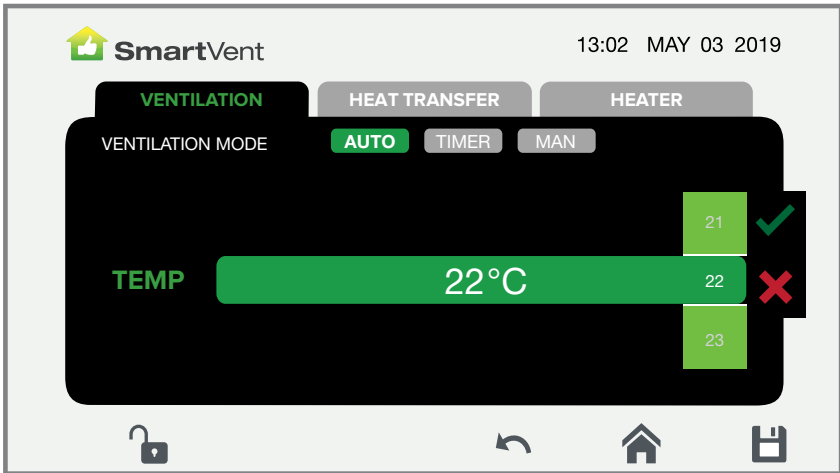

Quick Setup Guide

4 - Set Ventilation Mode and Temperature



- Press **SETTINGS**  on the home screen.
- Select the **VENTILATION** icon .
- Select **AUTO** ventilation mode.
- Press and scroll through the temperature options select your preferred indoor temperature.
- Press the tick to  confirm.
- Press **SAVE**  to save your changes.
- Press **HOME**  to return to the home screen.

Your standard SmartVent Synergy3 ventilation system is now set up and ready to operate.

For further instruction on how to set up Heat Transfer, go to page 23, or for Tempering Heater set up, go to page 26.

If your system has a Summer Feature installed your SmartVent Synergy3 controller will automatically select the best quality air from either the roof cavity, or the outside.

Screens and Navigation

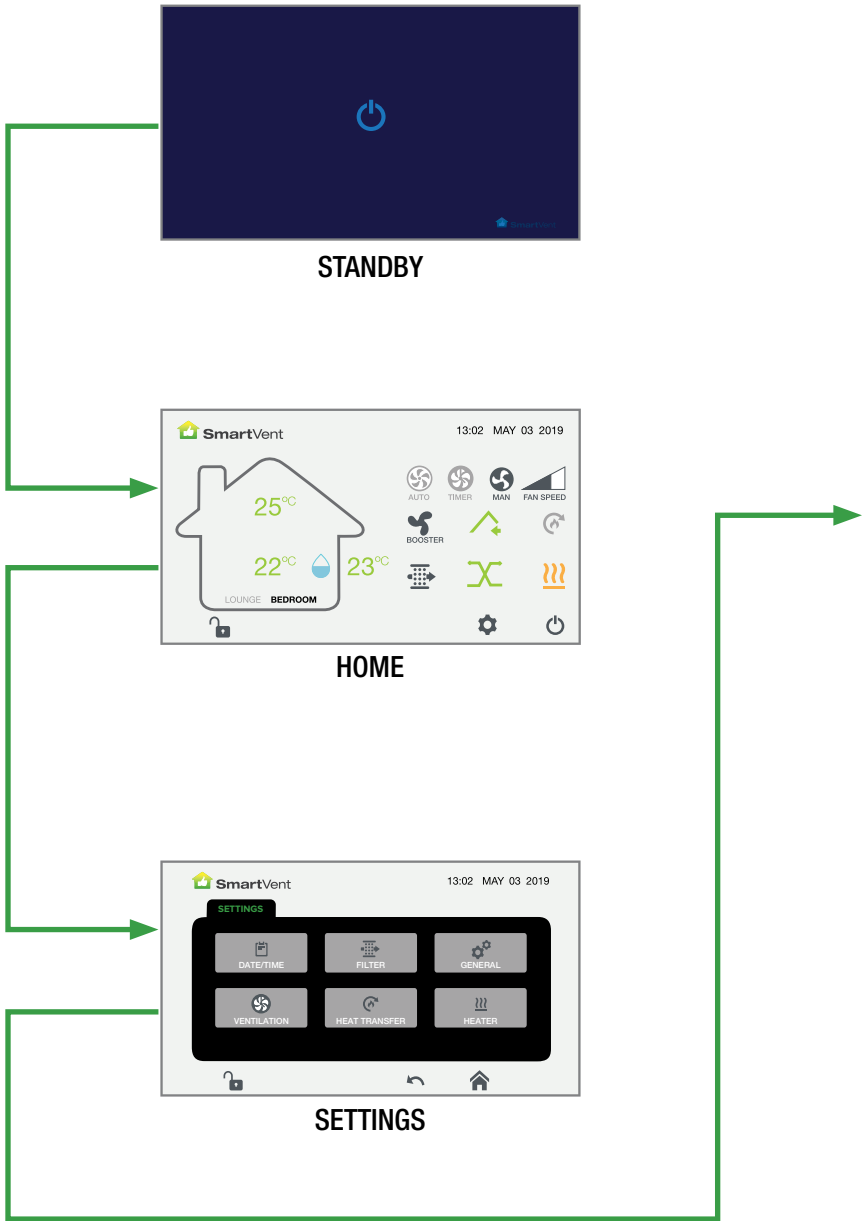

Screens and Navigation

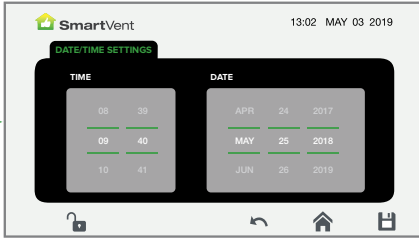

TIME-DATE

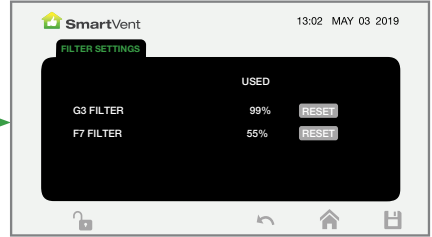

FILTER

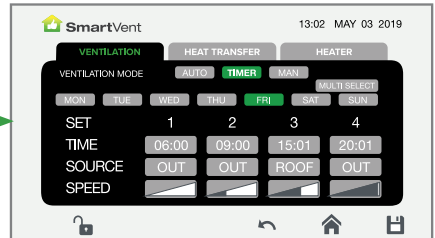
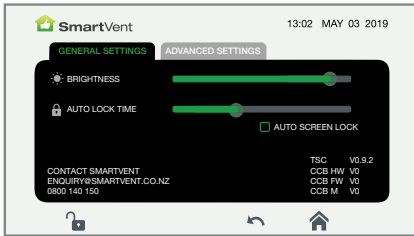

VENTILATION

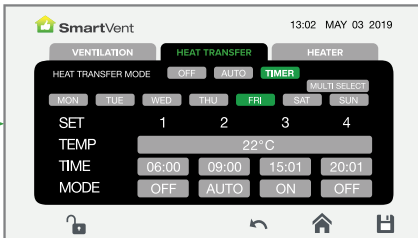

HEAT TRANSFER¹⁾

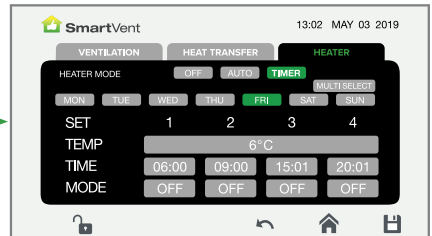

HEATER¹⁾



1) For more information about SmartVent system enhancements, contact 0800 140 150 or email enquiry@smartvent.co.nz

Standby Screen

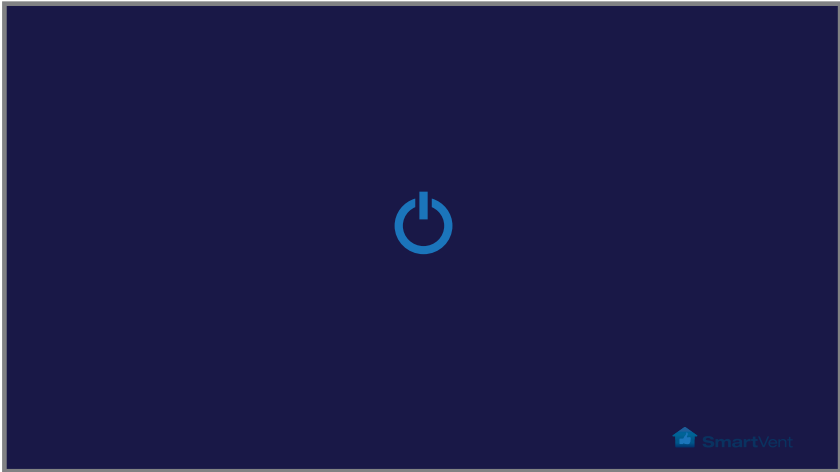
When your SmartVent Synergy3 controller is first powered on, the standby screen will be shown. Press the standby icon  in the middle of the screen to turn the system on.



Home Screen

If the screen is locked, press and hold the lock icon  for 5 seconds in the bottom left corner of the screen to unlock .

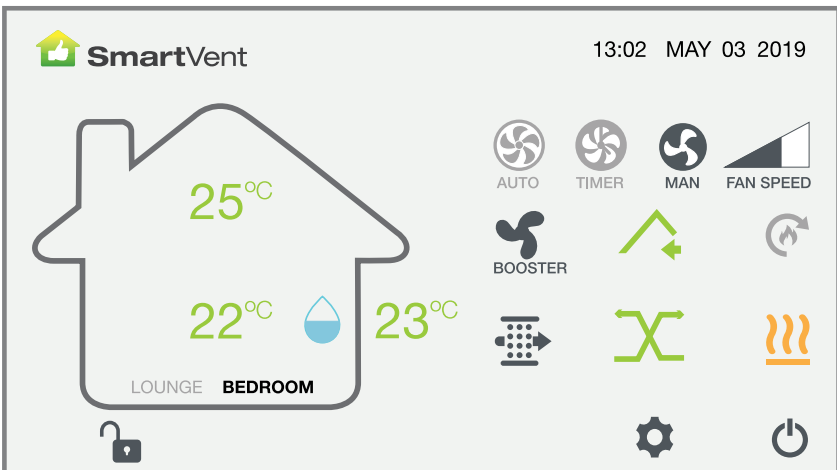

Home Screen Icons

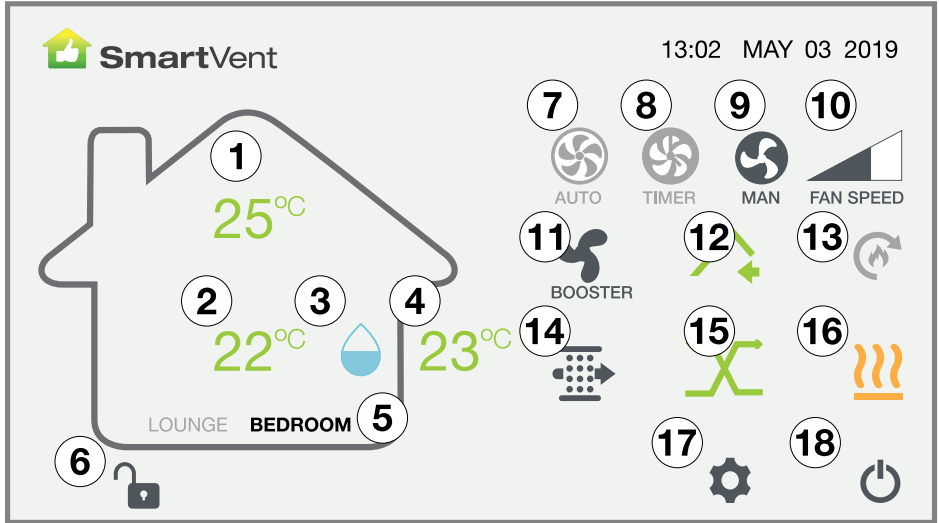

- 1 Roof Cavity Temperature
- 2 Indoor Temperature
(showing condition of room selected - LOUNGE or BEDROOM)
- 3 Indoor Dew Point
(showing condition of room selected - LOUNGE or BEDROOM)
- 4 Outdoor Temperature
- 5 Room Selection
(tap to select and view either LOUNGE or BEDROOM conditions)
- 6 Lock Button
(tap and hold for 5 seconds to lock and unlock)
- 7 Ventilation Mode - AUTO
(tap to activate Auto Vent mode)
- 8 Ventilation Mode - TIMER
(tap to activate Timer Vent mode)
- 9 Ventilation Mode - MANUAL
(tap to activate Manual Vent mode)
- 10 Fan Speed



Home Screen Icons

11 **Booster**
(tap to boost fan to highest speed for 20 minutes)

12 **Air Source¹**
(standard configuration) (Second Air Source feature required for this option)



13 **Heat Transfer¹ / Recycle**
(Heat Transfer required for this option)



14 **Filter Indicator²**
(check filter settings to see which filter needs to be changed)



15 **Operating System**



Heat/Energy Recovery

16 **Tempering Heater¹**
(Tempering Heater required for this option)



17 **Settings Navigation**

18 **Standby**

1) For more information about SmartVent system enhancements, contact 0800 140 150 or email enquiry@smartvent.co.nz

2) Failing to replace filters when due or installing filters other than genuine SmartVent filter replacements will void the warranty of your system

Settings

For further control options, visit the home screen and press the settings icon . You can navigate this menu by pressing any of the menu icons.



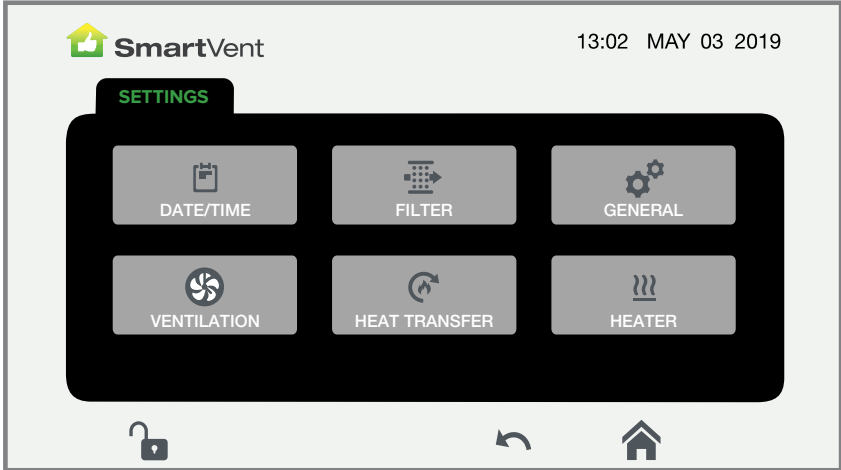

Note: Heat Transfer and Heater icons will not be visible if these upgrades¹⁾ are not installed.

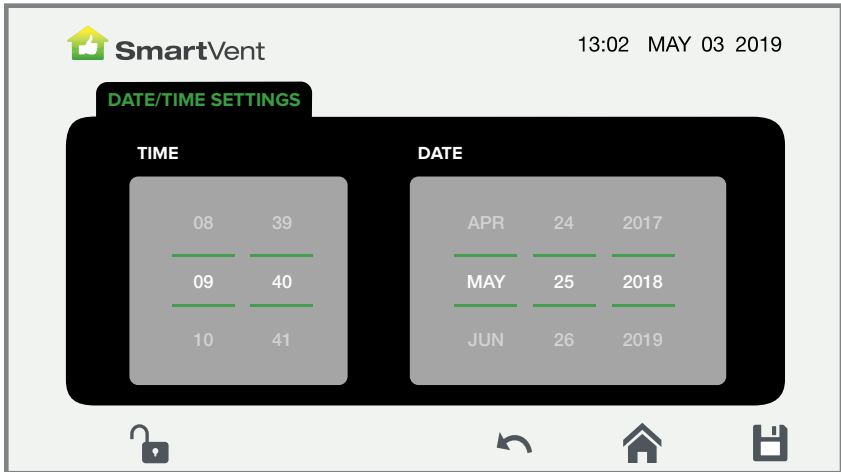

1) For more information about SmartVent system upgrades, contact 0800 140 150 or email enquiry@smartvent.co.nz

Time-Date



- 1 Press SETTINGS  on the home screen.
- 2 Select the **TIME-DATE** icon .
- 3 Scroll and select the current time and date.
- 4 Press SAVE  to save your changes.
- 5 Press HOME  to return to the home screen.

Note: Time needs to be manually changed when daylight saving begins and ends.

Filter

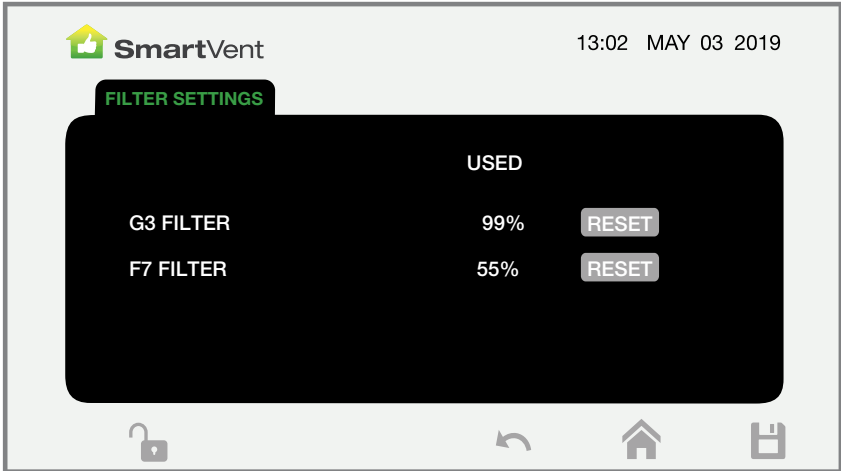

SmartVent Synergy3 systems are supplied with F7 filter(s). Not changing filters on time can affect the reliability and life expectancy of the system.

Expected life of F7¹⁾ filters: 12 Months

- 1 Turn your system OFF before removing used filters.
- 2 After replacing a filter, turn on your system and navigate to the FILTER SETTINGS screen, press the F7 filter RESET icon, and press the Save icon  to reset the filter timer.

Caution: Always install a genuine SmartVent filter to protect your system. SmartVent cannot guarantee the performance of non-genuine filters and how they work with our system, therefore use of non-genuine filters voids your system warranty.

- 3 Press Save icon  to save changes

1) See page 30 for other filter options

General Settings

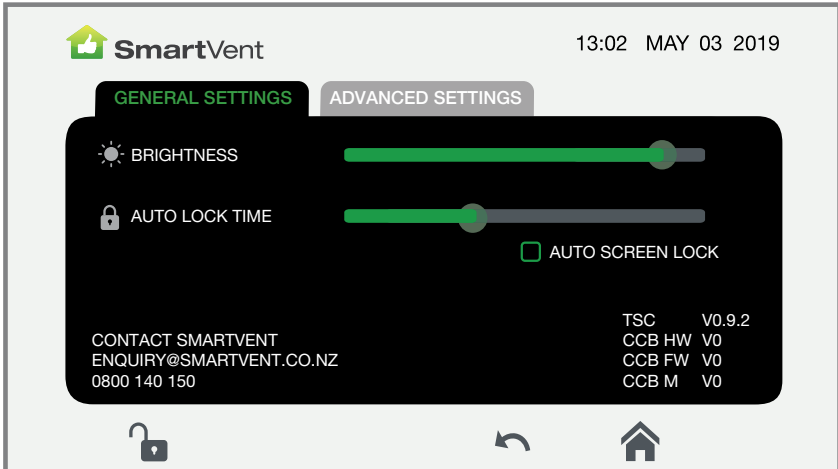

SCREEN BRIGHTNESS

Adjust to your preferred level of brightness by sliding to the left or right

AUTO LOCK TIMER

Adjust your preferred timeout setting for your screen by sliding to the left or right (adjustable from 30 seconds to 10 minutes)

AUTO SCREEN LOCK

Check this box to allow the screen to lock and enter a low power state when the timeout setting is reached.

Note: When the box is unchecked, the screen will not lock automatically.

General Settings

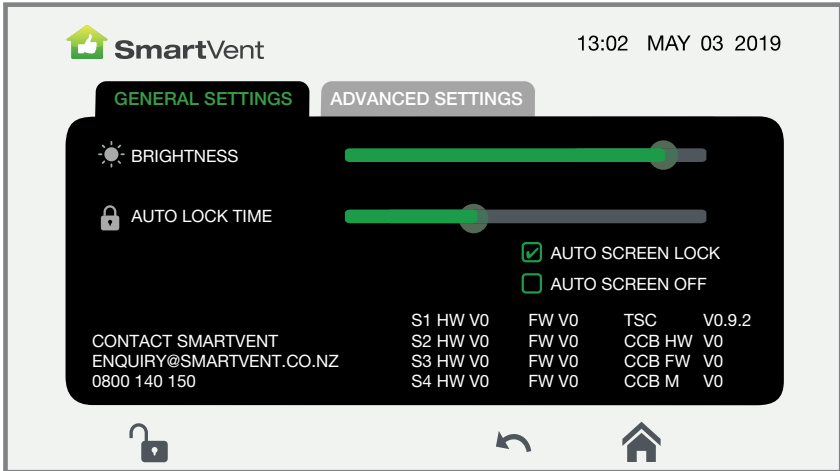

AUTO SCREEN OFF

This option is available when the AUTO SCREEN LOCK option is selected. Check this box to allow the screen to turn black when AUTO SCREEN LOCK conditions are reached.

Settings Interface

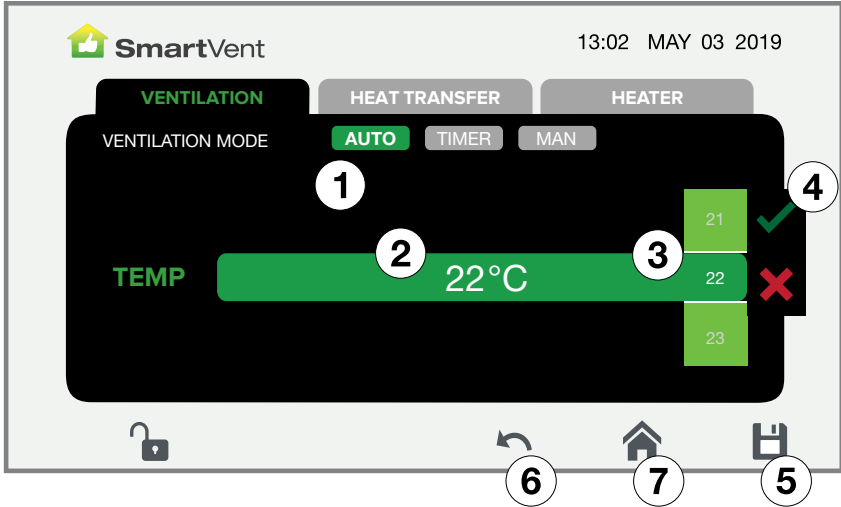

- 1 Choose the operating mode
- 2 Select a field to modify
- 3 Scroll and select your desired option
- 4 Press the tick ✓ to confirm your selection or cross ✗ to cancel
- 5 Press save icon 📁 to save changes
- 6 Press return to previous screen icon ↶ to the settings screen or,
- 7 Press the home icon 🏠 to return to the home screen

Note: The Save icon only appears when unsaved changes have been made.

Ventilation

AUTO Mode

Your SmartVent Synergy3 system chooses where to draw air from and at what speed depending on indoor dew point and temperature levels – in that order.

Your lounge and bedroom moisture levels have the highest priorities in dictating the fan speed, followed by temperature.

TEMP: This is your preferred indoor temperature.

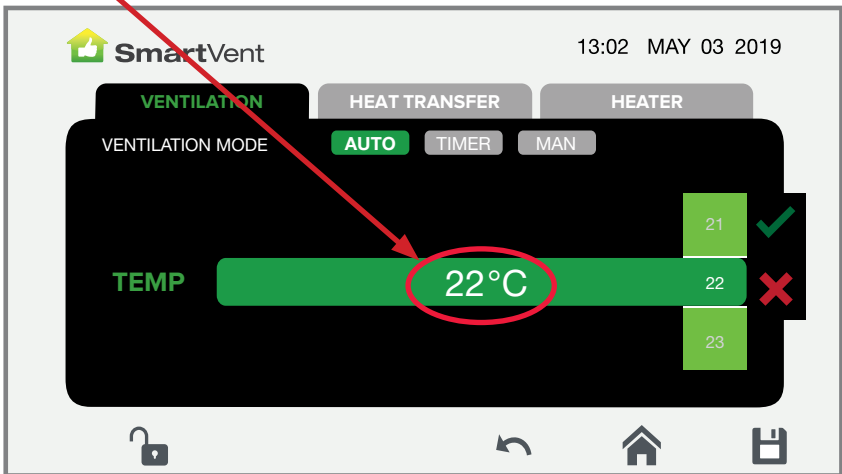

Press Save icon  to save changes

Ventilation

TIMER Mode

Your SmartVent Synergy3 system allows you to schedule any of the following functions, for four periods during the selected day, if required:

- Time
- Source (air)¹⁾
- Speed (fan)

To configure multiple days at the same time, press MULTI SELECT then choose the days you want to configure and then proceed as above. Settings will be applied to all days selected.

Press Save icon  to save changes

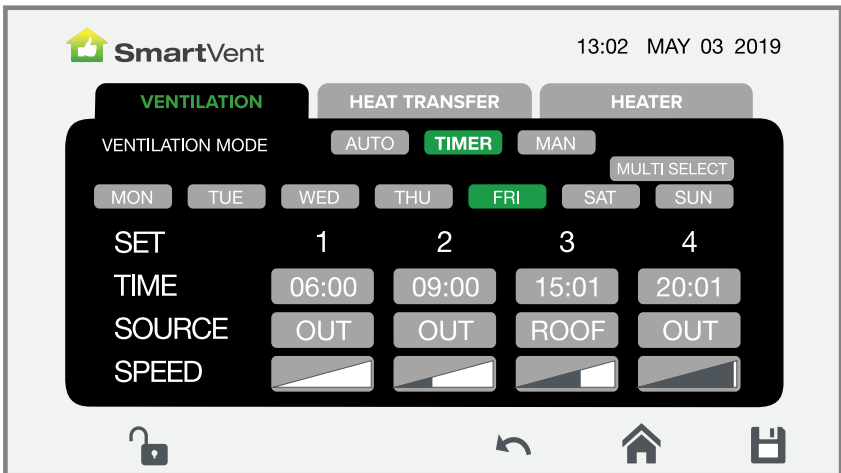

1) Only adjustable when Second Air Source is installed. For more information about SmartVent system enhancements, contact 0800 140 150 or email enquiry@smartvent.co.nz

Ventilation

MANUAL Mode

Your SmartVent Synergy3 system allows manual control of fan speed and air source if required.

Fan speeds can be altered manually by pressing (tapping) either of the fan speed icons.

Press Save icon  to save changes

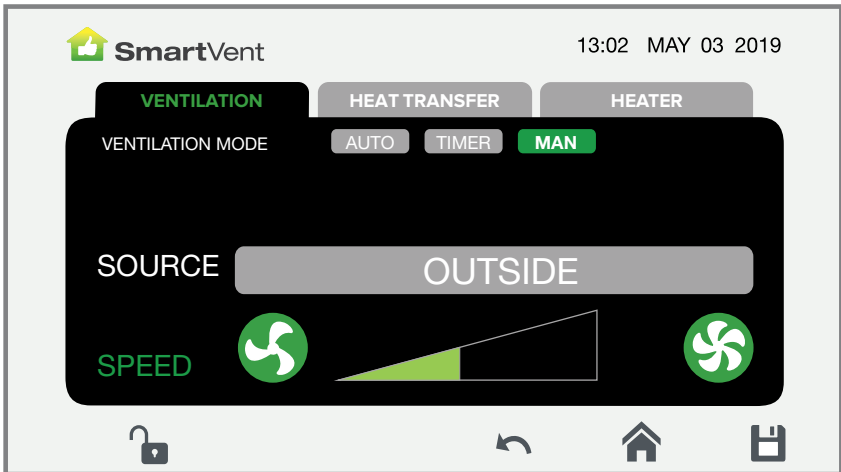

Heat Transfer

HEAT TRANSFER mode has priority over VENTILATION mode and there will be no control over moisture when HEAT TRANSFER is active. To ensure your home stays regularly ventilated, we recommend you use the timer function to turn HEAT TRANSFER OFF during the day, the middle of the night and early morning. We also recommend HEAT TRANSFER is set to AUTO in the evening.

OFF Mode

When HEAT TRANSFER mode is OFF, the system will operate in VENTILATION mode.

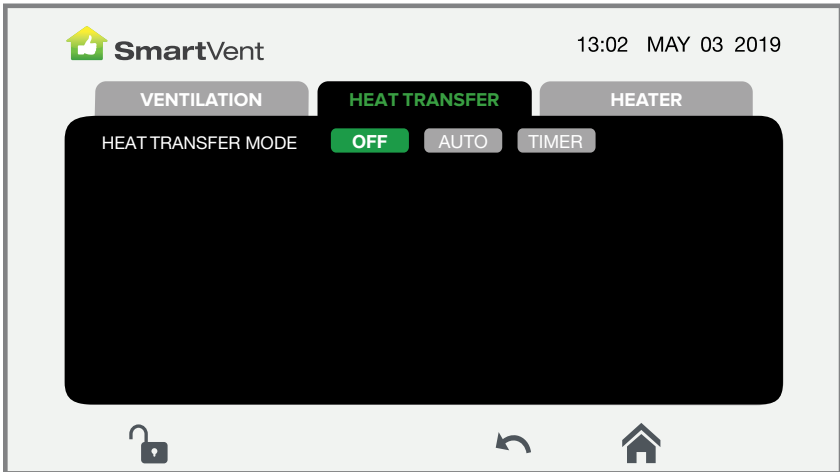

Heat Transfer

AUTO Mode

HEAT TRANSFER starts when the lounge temperature is higher than the set temperature. Your SmartVent Synergy3 system will revert to VENTILATION mode temporarily while the lounge is cooler than this temperature. Scroll and select the minimum temperature you want in your lounge before your system commences transferring heat.

Press Save icon  to save changes

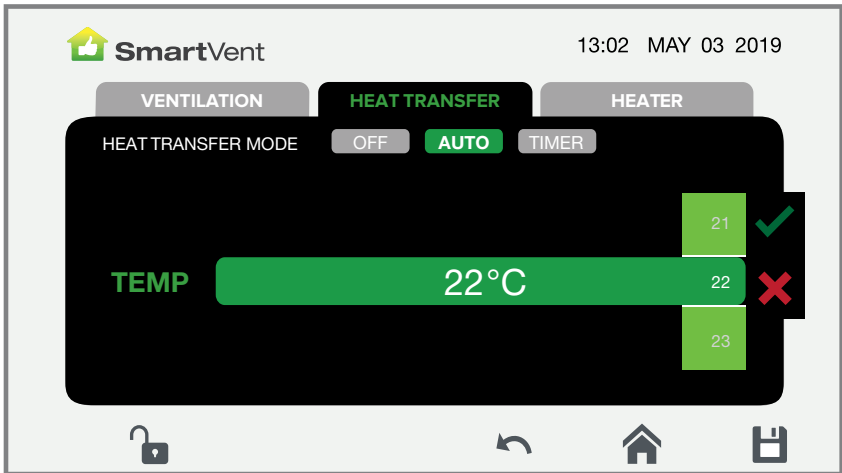

Heat Transfer

TIMER Mode

HEAT TRANSFER can be set to work to a schedule, use this function to make the most of your HEAT TRANSFER feature. We recommend you use the timer function to turn HEAT TRANSFER OFF during the day, the middle of the night and early morning. We also recommend HEAT TRANSFER is set to AUTO in the evening.

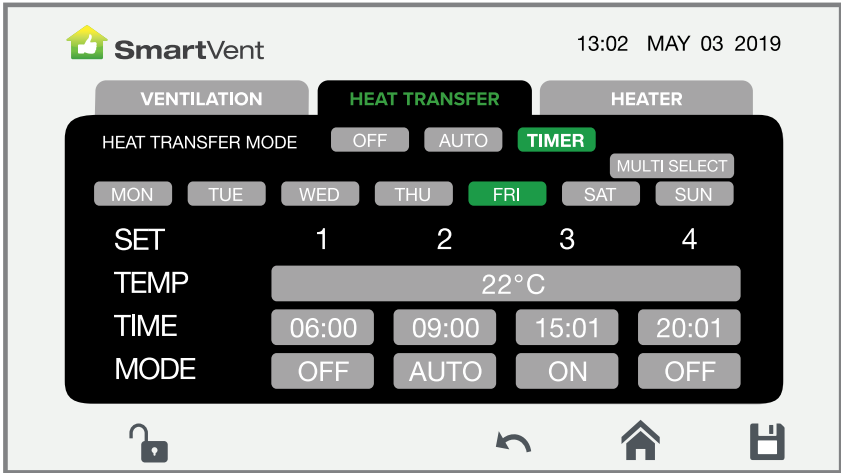

ON Mode

HEAT TRANSFER is on regardless of lounge temperature.

OFF Mode

HEAT TRANSFER is always off. System is in Ventilation Mode.

AUTO Mode

HEAT TRANSFER operates relative to the set temperature.

To configure multiple days at the same time, press MULTI SELECT then choose the days you want to configure and then proceed as above. Settings will be applied to all days selected.

Press Save icon  to save changes

Tempering Heater

Your TEMPERING HEATER works with VENTILATION mode to take the chill off incoming air. When the TEMPERING HEATER is active, the fans will run at a fixed medium speed. The TEMPERING HEATER is not designed to warm your home.

OFF Mode

The TEMPERING HEATER is off.

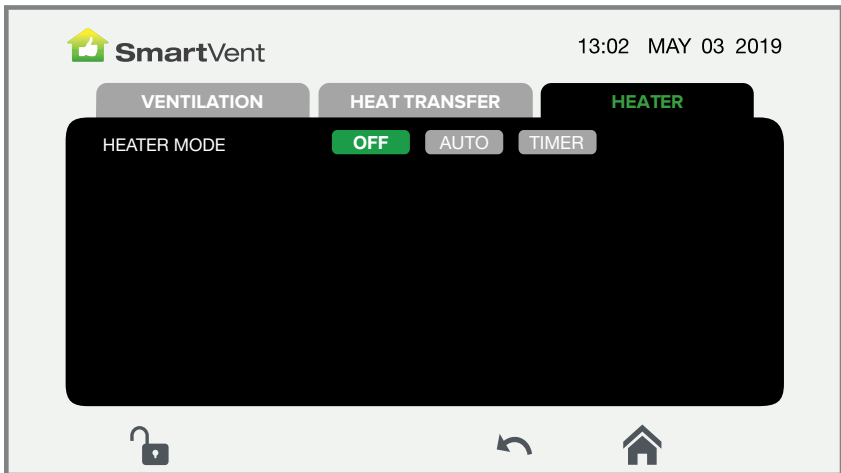

Tempering Heater

AUTO Mode

If a TEMPERING HEATER is installed, the heater turns on when the fresh air temperature is cooler than the set temperature.

Press Save icon  to save changes

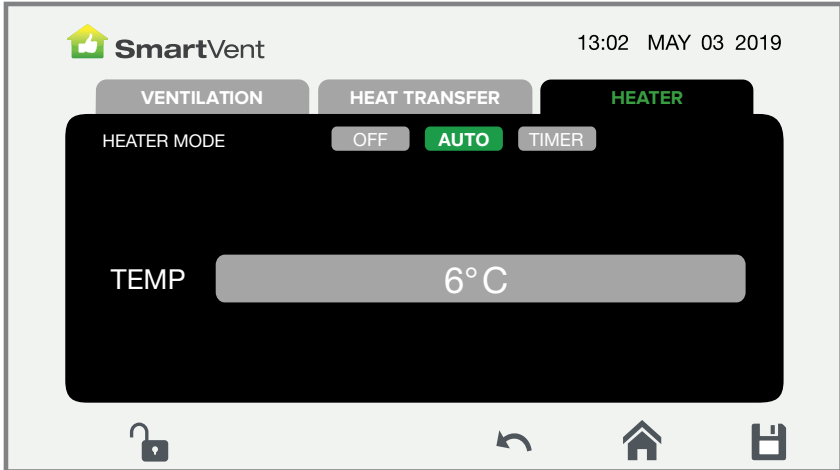

Tempering Heater

TIMER MODE

Your TEMPERING HEATER can be set to work to a schedule, use this function to reduce the running cost of your TEMPERING HEATER. We recommend you use the timer function to turn your TEMPERING HEATER OFF during the day and evening, and set to AUTO overnight and early morning.

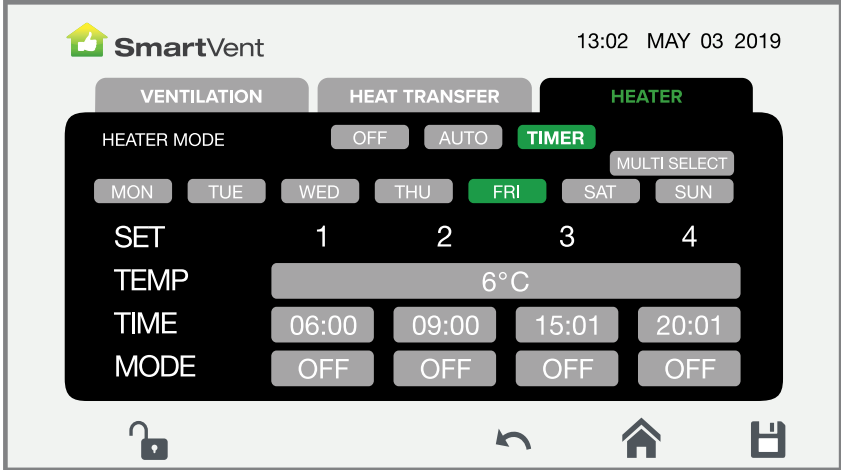

ON Mode

TEMPERING HEATER is on regardless of temperatures.

OFF Mode

TEMPERING HEATER is always off.

AUTO Mode

TEMPERING HEATER comes on as required based on the set temperature.

To configure multiple days at the same time, press MULTI SELECT then choose the days you want to configure and then proceed as above. Settings will be applied to all days selected.

Press Save icon  to save changes.

Recycle

This feature is only available with the HEAT TRANSFER kit and enabled in homes deemed likely to have damp air sources.

When your system is in AUTO VENTILATION Mode, and the fresh air sources are damper than your indoor air SmartVent will limit the amount of damp air entering your home.

If you have a Heat Transfer Kit¹⁾ installed you can set the recycle fan speed in the AUTO VENTILATION Mode page.

RECYCLE SPEED is your fan speed when your system is recycling indoor air.

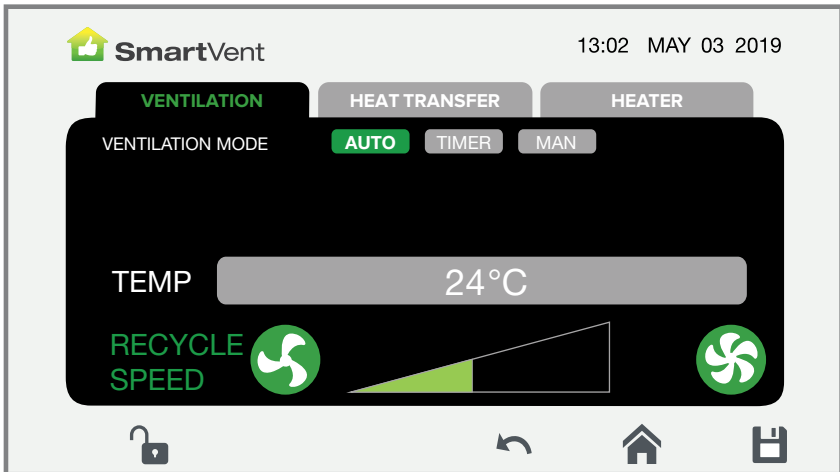

1) For more information about SmartVent system upgrades, contact 0800 140 150 or email enquiry@smartvent.co.nz

Maintenance



Filters

The filters will require changing when the Filter icon turns red.

Navigate to the FILTER page to see which filters are at 100% and replace them.

After replacing the filter select RESET next to the filter that has been replaced and tap the Save button.

G3 Filter

There are two G3 filters situated in the recovery ventilator.

The life span for the G3 filter is approximately six months (26 weeks) before reaching 100% filter usage. Once the G3 filters are FULL they will need to be cleaned.

1. Turn your Synergy3 system OFF at the mains and wait until the fans come to a complete stop before moving on to the next step.
2. Locate the recovery ventilator in the ceiling.
3. Unscrew the 4 screws of the access panel for about 12mm, slide the panel (A) along in the direction of arrow (as shown) and take it down.
4. Pull the filters down (B) which are located on both sides of the energy recovery core, outdoor air and room air side.
5. To clean the filters either wipe them gently with a damp cloth, wash them in warm soapy water or clean with a vacuum cleaner with a brush attachment.
6. Once clean and after allowing the filters to dry naturally (if washed), push the filters back into place ensuring that they fit correctly. Re-fasten the access panel by re-screwing the screws.
7. If the filters are unable to be cleaned correctly or are damaged, they should be replaced immediately and before the system is restarted (see order codes).
8. Turn your Synergy3 system back ON and reset the G3 filter timer.

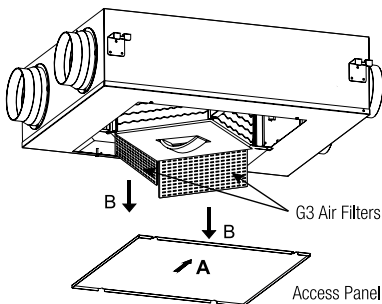

System	Qty	Filter	Order Code
SYN1015AD	2	G3	FAN6017
SYN2025AD	2	G3	FAN6018
SYN3035AD	2	G3	FAN6019
All	1	F7	DCT2093

Maintenance

F7 and HEPA Filters

Filter Grade	Order Code	Typical Life
F7	FAN2093	12 months
F7 Carbon ¹⁾	FAN2277	6 months
HEPA Carbon ¹⁾	FAN2278	6 months

Caution: When switching to a different grade of filter, remember to modify the KITS SETTINGS to get the correct filter change reminder.

See the INSTALLATION INSTRUCTIONS / Commissioning and Testing for instructions

Maintenance

Recovery Core

We recommend that the recovery core is cleaned once a year by completing the following steps:

1. Turn your Synergy3 system off at the mains and wait for the fans to come to a complete stop.
2. Locate the recovery ventilator in the ceiling.
3. Unscrew the four screws of the access panel for about 12mm, slide the panel (A) along in the direction of arrow and take it down.
4. Pull the two G3 filters down (B) which are located on both sides of the energy recovery core, outdoor air and room air side.
5. Loosen the baffle plate of the energy recovery core and move it to one side.
6. Holding onto the handle of the core, pull it along in the direction of arrow C, being careful to not pull too hard.
7. Using a vacuum cleaner with a brush attachment remove any dust or dirt.
8. After cleaning, reinstall the energy recovery core and G3 filters, close the access panel and re-fasten the screws.
9. Turn your Synergy3 system back ON.

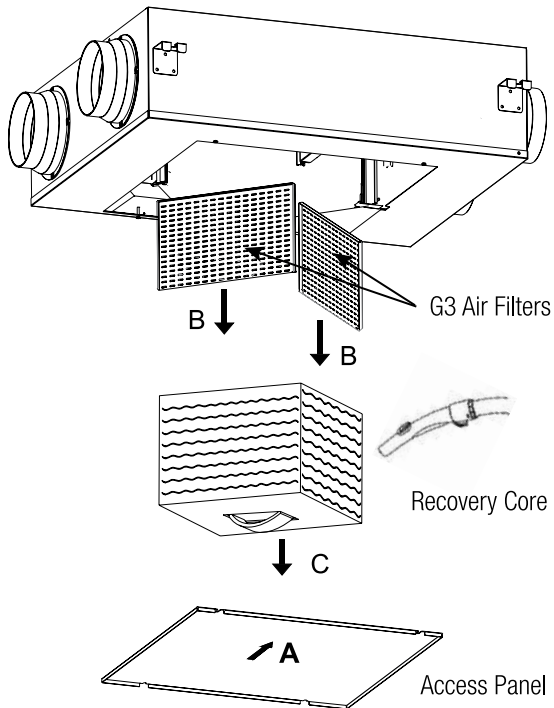

Maintenance

Replace Sensor Battery

The original battery provided with sensors is expected to last between 2 to 5 years or more.



- 1** **Step 1**
Turn the unit **counter-clockwise** gently. The lid should separate from the unit with an audible click. The battery compartment lid will remain adhered to the wall/ceiling.

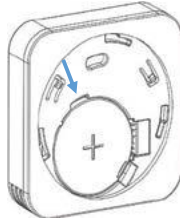

- 2** **Step 2**
Leverage the CR2032 coin cell from the compartment using a small tool as shown in image. Then insert the replacement battery back into the compartment.

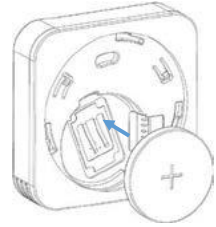

- 3** **Step 3**
Insert the replacement battery back into the compartment.

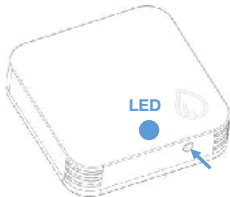

- 4** **Step 5**
Wait >3sec. Press the small button on the underside of the unit and observe the LED should flash once. (if not, see troubleshooting guide)

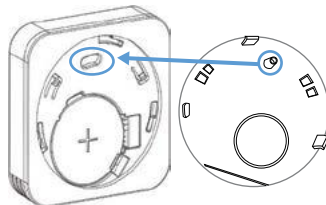

- 5** **Step 6**
Replace the unit back onto the battery compartment lid. Turn the unit **clockwise** gently. Locking the unit on the lid.





Note: Alignment guide must be inserted into the alignment slot when putting the battery cover on.

Troubleshooting

Can not pair device to App

- Ensure the correct pairing mode is selected. Switch pairing mode by turning the touch screen off and on **3 times**. It will alternate between Blink Quickly (2 seconds on - 2 seconds off) and Blink Slowly (4 seconds on - 2 seconds off). Choose the correct pairing mode on the App. If Blink Quickly pairing mode does not work then try Blink Slowly pairing mode.
- Ensure the Control Box is within the Wi-Fi router's range. Put system into Blink Slowly pairing mode and check the signal strength of the 'SmartLife-xxxx' is good when standing next to your router. If signal strength is poor move the router or add a Wi-Fi extender.
- Ensure the home router supports 2.4GHz Wi-Fi. 5GHz Wi-Fi is not supported by the product.

The touch screen is not responding to touch inputs

- 1 Check to see if the lock icon on the bottom left of the screen is closed .
- 2 If it is, press and hold the icon for 5 seconds to unlock .
- 3 The touch screen has an automatic screen lock function.
Go to the General Settings section on page 17 for more information about how to adjust this function.

There is condensation forming on my windows

- 1 Check that VENTILATION mode is set to AUTO
- 2 If HEAT TRANSFER is installed, ensure the timer function is utilised to allow periods dedicated to ventilating your home. See HEAT TRANSFER section on page 23 for additional information.
- 3 Test if air is coming out of the diffusers. If not then follow the steps in *There is no air coming out my diffusers* below.
- 4 To increase the velocity of air coming into the room, reduce the diffuser opening to 5-10mm.

Troubleshooting

There is no air coming out my diffusers

- 1 Check that the touch screen controller is powered on
- 2 Perform a manual test:
 - Set HEAT TRANSFER and HEATER modes to OFF
 - Set VENTILATION mode to MANUAL
 - Cycle through the fan speeds and check for air coming out of your diffusers
 - Make sure you check EVERY diffuser in the house
 - Return your system back to its original settings.
- 3 If there is no air coming out of at least one of your diffusers during the test, report the results to your installer.

My house feels colder with this system installed

- 1 Check your set temperature value in the VENTILATION settings.
- 2 Ventilation system brings in air from either the roof cavity or outside to improve the indoor air quality. This air can sometimes be cooler than your desired indoor temperature. This is normal.

My house is too hot

- 1 SmartVent systems are designed to provide ventilation to the home. Being able to cool the home down to a comfortable temperature in extreme temperatures is not guaranteed.

Dew Point level icon is grey

- 1 Contact SmartVent support.

Dew Point level are always poor

- 1 This indicates your system is trying to prevent condensation from forming on your windows.

Troubleshooting

Have I changed my filter properly?

- 1 Filter icon still shows as  after changing the filter
- 2 Filter reset required, see the filter section on page 16 for instructions.

The scheduler is not switching at the right time

- 1 The system has up to a 5 minute delay between switching states.
- 2 Check that your system clock time is correct. The system clock needs to be updated manually when daylight saving begins and ends.

When the Synergy3 heat transfer is ON, the fan speed displays OFF

- 1 This is normal as the recovery ventilator fans have turned off and the heat transfer fan has taken over.
- 2 Check your bedroom diffusers for airflow. If there is not air coming out, report the results to your installer.

Error Codes

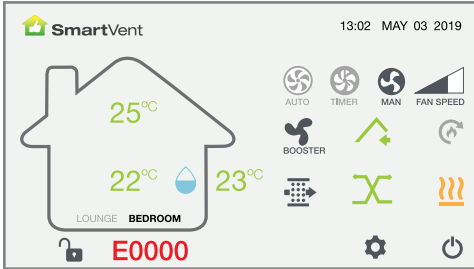

Error codes will appear on the Home Page when there is an electronic fault in the system. If there are multiple faults the error codes will cycle to the next code every 5 seconds.

Code	Description	Actions
E0000	Communication Error Between TSC and Ceiling Controller	Ensure connection between touch screen controller and ceiling controller is correct and secure, and cable is not damaged.
E0001	Clock Error	Change the time on the TSC.
E1080	Outside Sensor Com Failure	<ol style="list-style-type: none"> 1. Check the sensor battery is working by pressing the button on the sensor - the LED will flash once. 2. If the LED doesn't flash replace the battery with a fresh one - see sensor maintenance for how to change the battery.
E1180	Roof Sensor Com Failure	
E1280	Lounge Sensor Com Failure	
E1380	Bedroom Sensor Com Failure	
E4002	Sensor Pairing Not Initiated	Turn off the power to the ceiling controller for 30 seconds and begin sensor pairing process.

Contact SmartVent for support on 0800 140 150 if you see error codes not listed above or the actions above do not clear the errors.

Glossary

Air Source

The space where air is taken to ventilate your home. This is either the roof cavity or outside.

Diffuser

An attachment to help spread the flow of air. In a SmartVent Synergy3 system, it is usually the white round air outlet mounted on the ceiling.

Dew Point

The cooler temperature at which condensation, or water droplets (dew), form when warmer air comes in contact with a colder surface such as a window or glass surface. The SmartVent Synergy3 system can reduce the dew point of your indoor air and decrease the chances of condensation.

Heat Transfer

An optional add-on feature of the SmartVent Synergy3 system. The heat transfer function takes the excess heat from your designated room and transfers it to other areas via the SmartVent fan ducting system.

Intake Grille

An attachment to the ducting to prevent large objects being drawn into your system. In a SmartVent system, it is usually the white, square or round air inlet on the soffit, end of a duct in the roof space or, if you have a heat transfer upgrade installed, in your heat source room.

Positive Pressure System

Fresh, filtered air supplied from your roof cavity or outside and distributed into living areas in your home. This is the most common type of ventilation system sold in New Zealand.

Recovery Core

The core part of the Synergy3 system that tempers the outside air before it is used to ventilate the home. In winter, this will make the fresh air coming out of your diffuser warmer than the outside air.

Synergy3 System

The SmartVent range of heat recovery or energy recovery ventilation systems. They typically feature a ventilation method composing of a supply fan and a extract fan with a recovery core. Synergy3 is suitable for homes constructed after 2002.

Touch Screen Controller (TSC)

The SmartVent's touch screen user interface typically mounted on a wall inside your home.

Technical Specifications

Item	Data
Operating Voltage/Frequency	220-240V AC 50Hz
Switching Voltage	240V AC max
Switching Current	5A max resistive load
Controller Operating Temperature	0 to 50°C
Controller Operating Humidity	5-90% non condensing
Sensor Radio Frequency	868MHz
Sensor Operating Temperature	-20°C to 70°C
Sensor Operating Humidity	5-90% non condensing
Sensor Temperature Accuracy	±0.5%
Sensor Relative Humidity Accuracy	±5% at 10-30°C, 40-80% RH
Measurement Resolution - Sensor	0.1°C / 0.1% RH
Measurement Resolution - Controller Display	1°C
Wi-Fi Radio Frequency	2.4GHz
Live Output Isolation	Relay
Output Control	Relay
Display	7" colour touch screen
Safety Approval	AS/NZS 60335.1: 2020 +A1
EMC Approval	IEC CISPR 14-1 2020, ETSI EN 300 220-2 V3.2.1

Contact: 0800 140 150
enquiry@smartvent.co.nz



Distributed by Simx Limited
PO Box 14 347, Panmure, Auckland, NZ.
Technical Support (09) 259 1662 | e: enquiry@smartvent.co.nz | w: www.smartvent.co.nz

PUB1770 2302