



SmartVent
positive

HOME VENTILATION SYSTEMS



Firmware Version 3.7

User Manual

Your guide to a healthier home

Warning

- This appliance is not intended for use by persons (including children) with reduced physical, sensory or mental capabilities, or lack of experience and knowledge, unless they have been given supervision or instruction concerning use of the appliance by a person responsible for their safety.
- Children should be supervised to ensure that they do not play with the appliance.
- Isolate the mains supply before attempting to replace the system's air filter.

SmartVent Positive2 System

Firmware Version 3.7

Contents

How the System Works	4
Home Screen Icons	5
Button Functions	5
Screen Highlights.....	5
Modes	
Auto Operation and Temperature Setting	6
Manual Operation and System Fan Speed Setting	7
Boost	8
Recycle	8
Key Lock Setting.....	8
Heat Transfer	9
Tempering Heater	10
System Time-Date Settings	11
Scheduler Settings	12
Advanced Settings	
Advanced Setting Selection	13
Advanced Setting Menu	14
Troubleshooting	15
Maintenance	
Filter Replacement	16
Technical Specifications	16

How The System Works

Some features covered in this instruction manual are only available when installed and activated. Contact SmartVent for more information if you are interested in adding additional features to your system.

The SmartVent Positive2 System



SmartVent Positive2 is a positive pressure system which uses air taken from the roof cavity to ventilate your home.

Seasonal Upgrades ¹⁾



Summer Feature

Adds outside air as second air source for continued quality ventilation in warmer months supplying outdoor air when the roof cavity temperature exceeds that of the outside air.



Heat Transfer

To draw excess heat from your heated lounge and transfer it to bedrooms. Includes a recycle function where inside air can be recirculated if the outside air temperature is too cold to bring in as part of the primary ventilation process.



Tempering Heater

To help take the chill off incoming air (*not a home heating solution*).

When seasonal upgrades are added, your system can offer greater options in how it operates.

The options can override or influence one another as in the following examples.

Example: When the environment in your home meets your chosen heat transfer condition the ventilation and tempering heater functions deactivate.

Example: When the system is ventilating and conditions are met for the heater to turn on, the speed of the fan will be influenced by the heater function.

¹⁾ For more information about SmartVent seasonal upgrades, contact 0800 140 150 or email enquiry@smartvent.co.nz



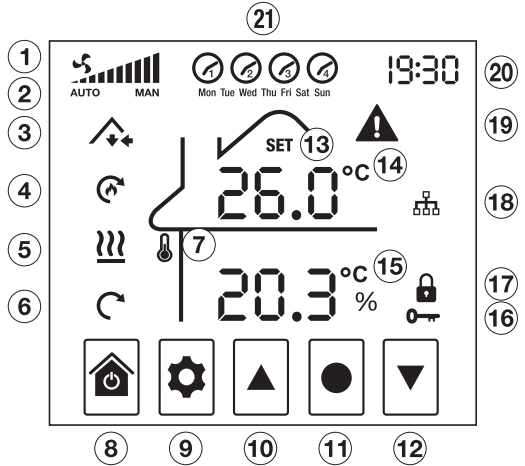

Home Screen Icons

- ① System Fan Speed
- ② Ventilation Mode ¹⁾
- ③ Air Source Indicator
- ④ Heat Transfer ON ²⁾
- ⑤ Tempering Heater ON ²⁾
- ⑥ Recycle ON
- ⑦ Temperature Sensing ON
- ⑧ Home and Power
- ⑨ Settings
- ⑩ Up
- ⑪ Select
- ⑫ Down
- ⑬ Set ³⁾
- ⑭ Fresh Air Temperature ³⁾
- ⑮ Current Room Temperature
- ⑯ Key Lock ON
- ⑰ Rental Mode ON ⁴⁾
- ⑱ COMs ⁵⁾
- ⑲ Alert ⁶⁾
- ⑳ Time ⁷⁾
- ㉑ Scheduler Period and Day



- 1) Ventilation mode selections are AUTO or MAN (manual)
- 2) Only displayed if the seasonal upgrade is installed
- 3) The SET icon will appear when the temperature is being changed and the progressive temperature changes being made will be displayed instead of the Fresh Air temperature
- 4) When RENTAL mode is ON, user cannot switch system OFF
- 5) Flashes when communicating with ceiling controller
- 6) When an electronic fault in the system occurs, the alert icon will appear and the applicable error code(s) will be displayed instead of the time
- 7) Time is displayed in a 24 hour clock format

Button Functions

-  Power OFF/ON or discard selections and return to Home Screen
-  From Home Screen enter setting screen or return to previous setting option
-   Scroll through setting options and change setting values
-  Save setting selection and go to next setting option

Screen Highlights

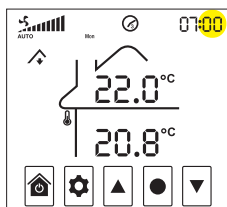

Yellow highlight
indicates icon
is flashing

Green highlight
indicates button(s)
to push







Modes

Auto Operation and Temperature (TEMP) Setting

Your SmartVent Positive2 system can choose where to draw air from and at what speed depending on the indoor and outdoor air temperatures, when in AUTO. If the system is in either BOOST or RECYCLE modes, the fan will, instead, operate at the speeds set for those particular modes.

You select the SET temperature you want it to be in the home (ie. 22°C (default)) and the system will work on the best air source to achieve your SET temperature ¹⁾.

For example, if you set your system to 20°C while the current house temperature is 18.3°C, the control system measures the incoming air temperature and alters the fan speed to suit. If the incoming air temperature is 20°C or higher, the fan will operate at a high speed to use the free heat to try and increase the overall house temperature. If lower than 20°C, the fan speed would decrease to reduce the cooling effect ²⁾.

- On the Home Screen, press SETTINGS  and then UP , or DOWN , to toggle to VENTILATION mode
- Press SELECT  to enter VENTILATION mode then UP , or DOWN , to toggle to AUTO operation and follow the guide below to complete the setting of the SET temperature.
- Alternately, if already in ON and on the Home Screen, press SELECT  to toggle directly to AUTO operation and follow the same guide below to adjust the temperature setting.

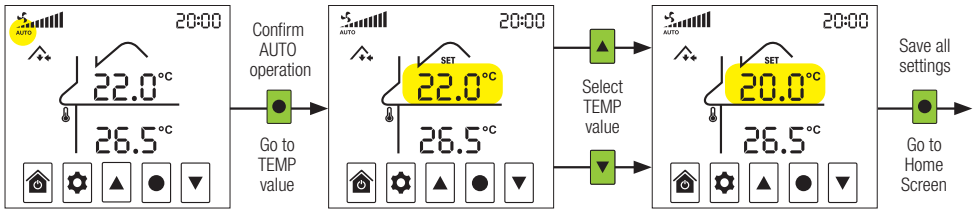







1) Your system is not a heating or cooling device. This parameter is designed to reduce nuisance over-heating or over-cooling of your home.
2) Additional features are available when low temperatures are present. See HEAT TRANSFER, TEMPERING HEATER and RECYCLE modes.

Modes

Manual (MAN) Operation and System Fan Speed and Air Source Settings

Your SmartVent Positive2 system allows manual control of the fan speed and air source if required. Fan speed will remain constant at the speed set.

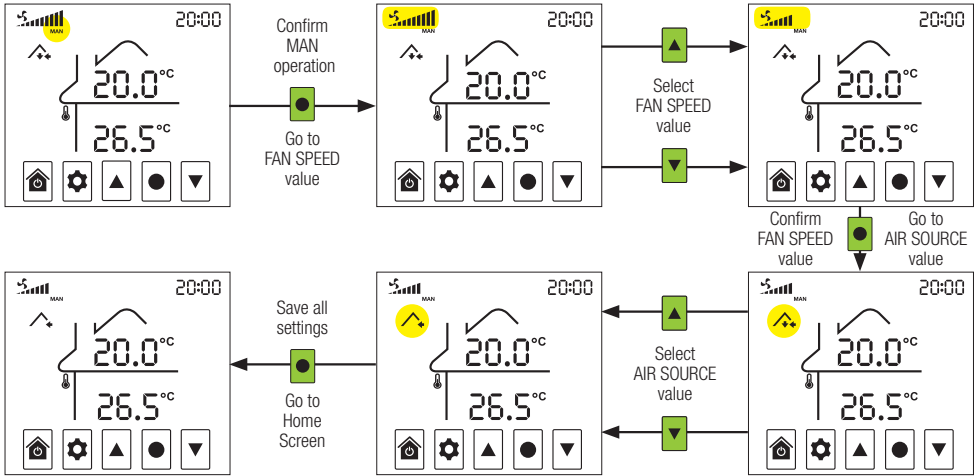

- On the Home Screen, press SETTINGS  and then UP , or DOWN , to toggle to VENTILATION mode
- Press SELECT  to enter VENTILATION mode and then UP , or DOWN , to toggle to MAN operation and follow the guide below to complete the setting of the system fan speed and the selection of the air source.
- Alternately, if already in ON and on the Home Screen, press SELECT  to toggle to MAN operation and follow the same guide below to change the system fan speed.



Modes

Boost

BOOST enables you to immediately override fan speed settings and boost fan speed to maximum.

- On the Home Screen, press SELECT  for 3 seconds and system's fan will boost to maximum speed.
- In BOOST mode, the time segments will become a count down to the end of the BOOST mode.
- A quick tap of SELECT  on the Home Screen will exit BOOST mode.

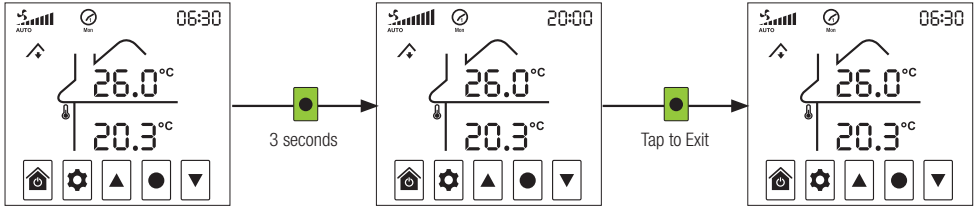

Recycle

RECYCLE is designed for environments where extremes of temperature are common. When your system is in VENTILATION mode and the roof cavity temperature exceeds the maximum roof cavity temperature (30°C) setting, or goes below the minimum roof cavity temperature (5°C) setting, your SmartVent system will limit the amount of air entering your home.

If HEAT TRANSFER is installed, the RECYCLE  icon will be displayed to indicate that your system is in RECYCLE mode recycling indoor air to help reduce condensation build-up. In RECYCLE mode the fan will operate at the Recycle speed you set in the Recycle setting (default = OFF). Recycle temperature settings (004 and 005) can be adjusted in the Advanced Setting Menu on page 13.

If a HEAT TRANSFER kit is not installed, it is recommended that Recycle speed is set to OFF.



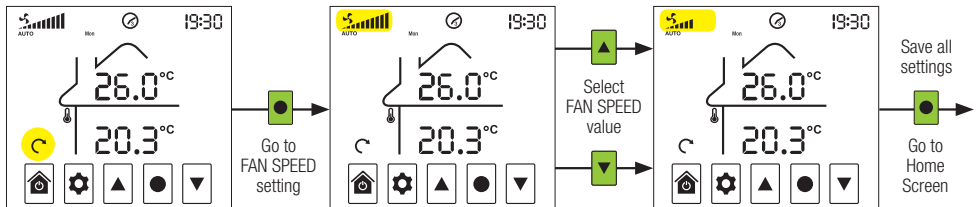



- On the Home Screen, press SETTINGS  and then UP , or DOWN , to toggle to RECYCLE mode and follow the guide below to complete.



RECYCLE mode may need to be activated. See Installation Instructions for details.

Key Lock Setting

When Key Lock is ON, system settings cannot be changed

- Press UP  and DOWN  together for 3 seconds, until the KEY LOCK  icon is displayed, to confirm that the system is locked.
- Press UP  and DOWN  together for 3 seconds, until the KEY LOCK  icon is not displayed, to confirm that the system is unlocked.







Heat Transfer

When HEAT TRANSFER is ON, the fan speed will be low when the lounge temperature exceeds the SET temperature, and it will gradually speed up as your lounge gets warmer.

HEAT TRANSFER mode has priority over VENTILATION mode. To ensure your home stays regularly ventilated, we recommend you use the timer function to turn HEAT TRANSFER OFF during the day, the middle of the night and early morning. We also recommend HEAT TRANSFER is set to ON in the evening.







OFF Mode

HEAT TRANSFER mode is OFF.

- On the Home Screen, press SETTINGS  and then UP , or DOWN , to toggle to HEAT TRANSFER mode
- Press SELECT  to enter HEAT TRANSFER mode
- Press UP , or DOWN , to toggle to OFF and press SELECT  to save

ON Mode and Temperature (TEMP) Setting

HEAT TRANSFER starts when the lounge temperature is higher than the temperature you choose. SET is the minimum temperature you want in your lounge before your system commences transferring heat. The SmartVent Positive2 touch screen controller, with a built-in thermostat, must be located in the heat source room for it to be effective.

- On the Home Screen, press SETTINGS  and then UP , or DOWN , to toggle to HEAT TRANSFER mode
- Press SELECT  to enter HEAT TRANSFER mode
- Press UP , or DOWN , to toggle to ON and follow the guide below to complete

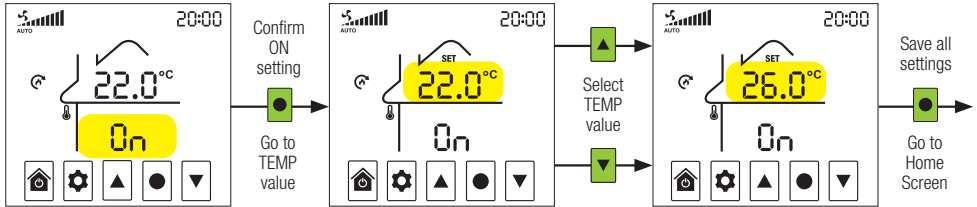

SCHEDULER Mode

HEAT TRANSFER can be set to work to a schedule which enables you to make the most of your HEAT TRANSFER feature. We recommend you use the timer function to turn HEAT TRANSFER OFF during the day, the middle of the night and early morning. We also recommend HEAT TRANSFER is set to ON in the evening.







See Scheduler Settings for detail on how to set up the scheduled times on pages 11 and 12

Tempering Heater

Your TEMPERING HEATER works with VENTILATION mode to take the chill off incoming air. When the TEMPERING HEATER is active, the fans will run at medium speed. The TEMPERING HEATER is not designed to warm your home, however, it will take the chill off the incoming air.







OFF Mode

TEMPERING HEATER is OFF.

- On the Home Screen, press SETTINGS  and then UP , or DOWN , to toggle to TEMPERING HEATER mode
- Press SELECT  to enter TEMPERING HEATER mode
- Press UP , or DOWN , to toggle to OFF and press SELECT  to save

ON Mode and Temperature (TEMP) Setting

The TEMPERING HEATER turns ON when the fresh air temperature is cooler than the SET temperature.

- On the Home Screen, press SETTINGS  and then UP , or DOWN , to toggle to TEMPERING HEATER mode
- Press SELECT  to enter TEMPERING HEATER mode
- Press UP , or DOWN , to toggle to ON and follow the guide below to complete

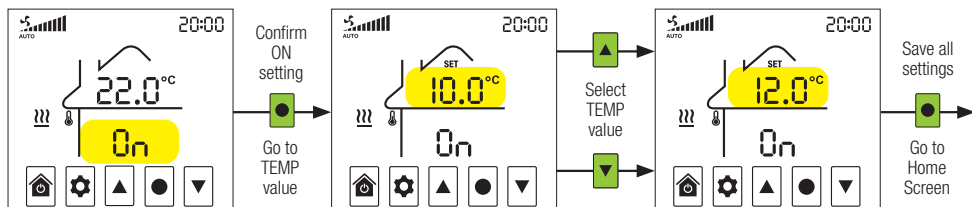

SCHEDULER Mode

TEMPERING HEATER can be set to work to a schedule which can reduce the running cost of your TEMPERING HEATER. We recommend you use the timer function to turn your TEMPERING HEATER OFF during the day and evening, and set to ON overnight and early morning.

TEMPERING HEATER will be disabled if HEAT TRANSFER is operating.



See Scheduler Settings for detail on how to set up the scheduled times on pages 11 and 12

System Time-Date Settings

System Time-Date Settings must be entered before system functions, such as scheduled start times for HEAT TRANSFER and TEMPERING HEATER (if installed), can be set.

- On the Home Screen, press SETTINGS  for 3 seconds to enter Time-Date Settings and follow the guide below to complete

NOTE: Settings shown are examples only

- Press HOME  at any stage to exit and enter Scheduler Settings
- Press SETTINGS  at any stage to return to the previous screen

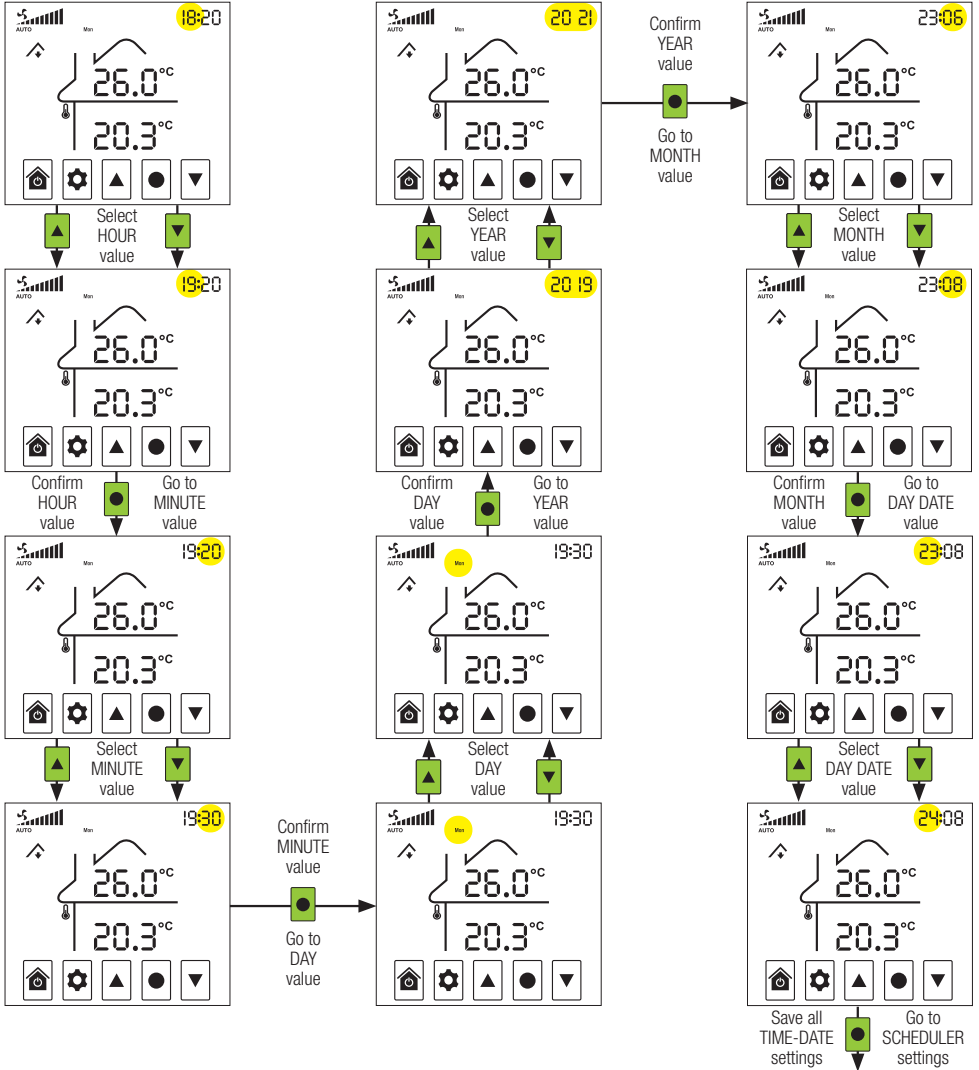

System Operating Settings



Scheduler Settings



Setting the Scheduler is only necessary if you want HEAT TRANSFER or TEMPERING HEATER to operate for predetermined times during each of the four periods available every 24 hours. Each period of time starts with the scheduled start time for that period and ends at the start time for the next scheduled period.

Scheduler can be used with HEAT TRANSFER and TEMPERING HEATER seasonal upgrades and the period time settings are common to both if installed. VENTILATION and TEMPERING HEATER functions will be disabled if HEAT TRANSFER is operating.

- On the Home Screen, press SETTINGS  for 3 seconds then press HOME  to enter Scheduler Settings and follow the guide below to complete

NOTE: Settings shown are examples only

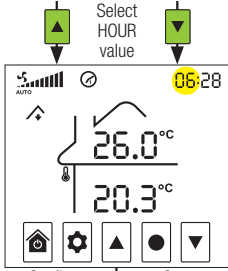
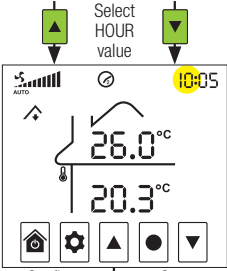
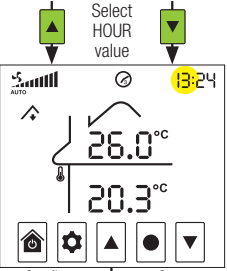
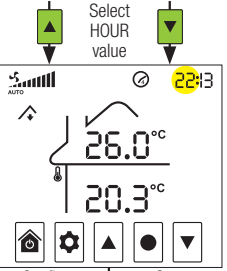
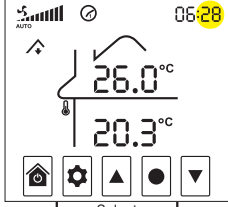
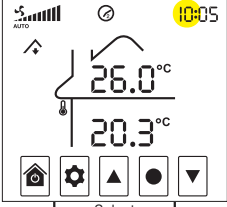
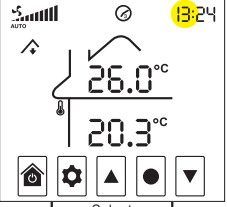
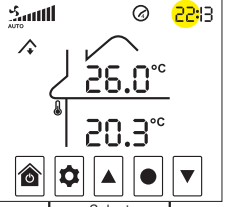
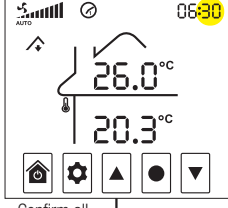
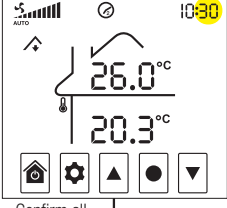
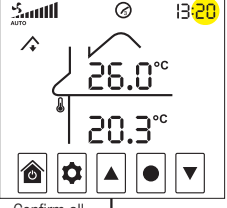
- Press HOME  at any stage to exit Scheduler Settings and return to the Home Screen
- Press SETTINGS  at any stage to return to the previous screen

Period 1	Period 2	Period 3	Period 4
 <p>Select HOUR value</p> <p>06:28</p> <p>26.0°C</p> <p>20.3°C</p> <p>Confirm HOUR value</p> <p>Go to MINUTE value</p>	 <p>Select HOUR value</p> <p>10:05</p> <p>26.0°C</p> <p>20.3°C</p> <p>Confirm HOUR value</p> <p>Go to MINUTE value</p>	 <p>Select HOUR value</p> <p>13:24</p> <p>26.0°C</p> <p>20.3°C</p> <p>Confirm HOUR value</p> <p>Go to MINUTE value</p>	 <p>Select HOUR value</p> <p>22:43</p> <p>26.0°C</p> <p>20.3°C</p> <p>Confirm HOUR value</p> <p>Go to MINUTE value</p>
 <p>06:28</p> <p>26.0°C</p> <p>20.3°C</p> <p>Select MINUTE value</p>	 <p>10:05</p> <p>26.0°C</p> <p>20.3°C</p> <p>Select MINUTE value</p>	 <p>13:24</p> <p>26.0°C</p> <p>20.3°C</p> <p>Select MINUTE value</p>	 <p>22:43</p> <p>26.0°C</p> <p>20.3°C</p> <p>Select MINUTE value</p>
 <p>06:30</p> <p>26.0°C</p> <p>20.3°C</p> <p>Confirm all PERIOD 1 settings</p> <p>Go to PERIOD 2</p>	 <p>10:30</p> <p>26.0°C</p> <p>20.3°C</p> <p>Confirm all PERIOD 2 settings</p> <p>Go to PERIOD 3</p>	 <p>13:20</p> <p>26.0°C</p> <p>20.3°C</p> <p>Confirm all PERIOD 3 settings</p> <p>Go to PERIOD 4</p>	 <p>22:00</p> <p>26.0°C</p> <p>20.3°C</p> <p>Save all PERIOD 1-4 settings</p> <p>Go to Home Screen</p>

Advanced Settings

Advanced Setting Selection

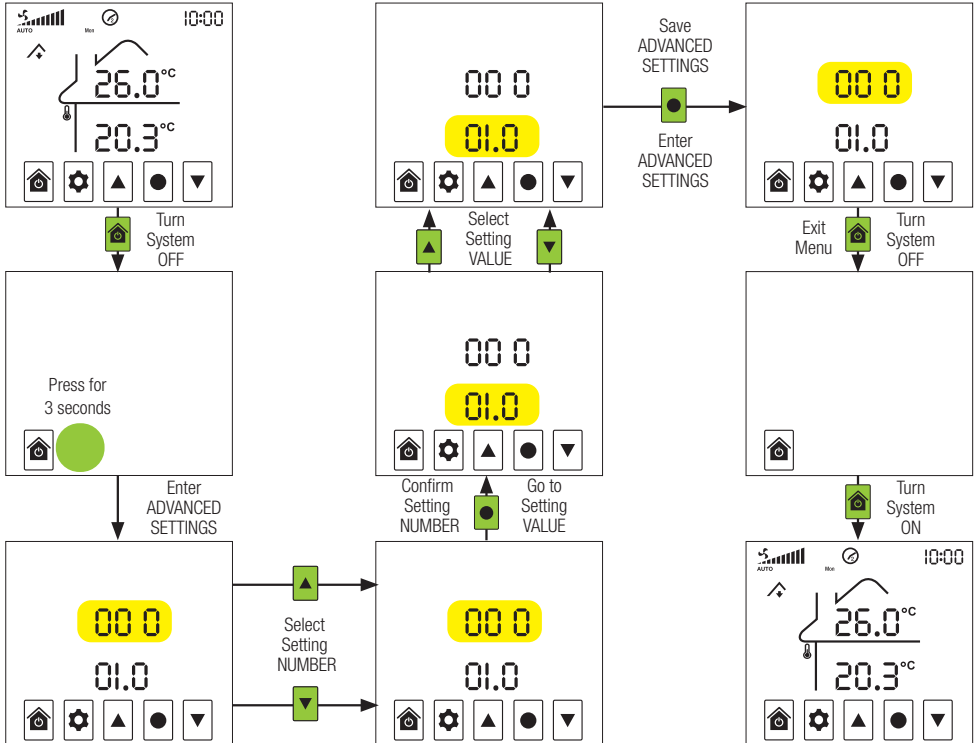

Advance Settings enable you to change your SmartVent Positive2 system settings at any time to ensure you gain maximum benefit of comfortable living conditions in a healthy home. Access to Advanced Settings is disabled when RENTAL mode is ON.



Advanced Settings

Advanced Setting Menu

SETTING	DESCRIPTION	RANGE	DEFAULT	NOTE
000	Touch Screen Controller - Firmware Version	N/A	N/A	
001	Ceiling Controller - Hardware Version	N/A	N/A	
002	Ceiling Controller - Firmware Version	N/A	N/A	
003	Ceiling Controller - Macro Version	N/A	N/A	
004	Recycle Temperature - Maximum	20°C - 50°C	30°C	1
005	Recycle Temperature - Minimum	0°C - 20°C	5°C	1
006	Temperature Set - Threshold	0°C - 5°C	1°C	
007	Temperature Set - Differential	0°C - 20°C	5°C	
008	Heat Transfer Speed - High	0°C - 15°C	5°C	
009	Heat Transfer Speed - Medium	0°C - 15°C	2°C	
010	Reserved	N/A	N/A	
011	Reserved	N/A	N/A	
012	Reserved	N/A	N/A	
013	Filter Used Percentage	0 – 100%	0%	
014	Temperature - Roof Cavity	-5°C - 5°C	0°C	2
015	Temperature - Room	-5°C - 5°C	-0.5°C	2
016	Screen Brightness - Maximum	0-100%	80%	
017	Screen Brightness - Minimum	0-100%	10%	
018	Boost Time	0 min – 60 min	20 min	
019	Filter Reset	0 - 100	0	3

1. If RECYCLE  is enabled and the roof cavity sensor reading goes above the maximum recycle temperature setting or goes below the minimum recycle temperature setting, then recycle mode will activate.
2. If your roof cavity or room temperature readings are inaccurate, use these settings to calibrate them.
3. To reset the filter change 019 setting value to 10 and press SELECT .

Troubleshooting

An ALERT  icon and an error code will appear on the Home Screen when there is an electronic fault in the system.

If there are multiple faults the error codes will cycle to the next code periodically.

Contact SmartVent for assistance if error codes not listed above appear or the actions above do not clear the errors.

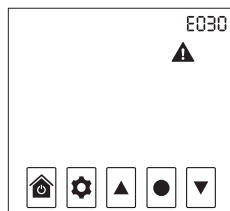

CODE	DESCRIPTION	ACTION
E030	Communication error between the touch screen controller and the ceiling controller	Ensure the connection between the touch screen controller and the ceiling controller is correct and secure, and that the cable is not damaged
0001	Clock error	Change the time on the touch screen controller
1138	Roof sensor com failure	Ensure the connection between the sensor and the ceiling controller is secure, and that the cable is not damaged
1280	Lounge sensor com failure	
FILE	Filter change required	Replace filter and reset filter by changing Advanced Setting 019 to 10 and pressing SELECT to confirm

There is condensation forming on my windows

- 1 Check that VENTILATION mode is set to AUTO
- 2 If HEAT TRANSFER is installed, ensure the scheduler is utilised to allow periods dedicated to ventilating your home. See HEAT TRANSFER section on page 7 for additional information.
- 3 Test if air is coming out of the diffusers. If not then follow *There is no air coming out my diffusers* steps below.
- 4 To increase the velocity of air coming into the room, reduce the diffuser opening to 5-10mm.

There is no air coming out my diffusers

- 1 Check that the touch screen controller is powered ON.
- 2 Perform a manual test:
 - Set HEAT TRANSFER and TEMPERING HEATER modes to OFF
 - Check RECYCLE mode is OFF. If it is ON then adjust your Recycle Temperatures to turn RECYCLE mode OFF (see SETTINGS 004 and 005).
 - Set VENTILATION mode to MANUAL
 - Cycle through the fan speeds and check for air coming out of your diffusers
 - Make sure you check EVERY diffuser in the house
 - Return your system back to its original settings.
- 3 If there is no air coming out of at least one of your diffusers during the test, report results to your installer.

My house feels colder with this system installed

- 1 Check your set temperature value in the VENTILATION settings.
- 2 Ventilation system brings in air from either the roof cavity or outside to improve the indoor air quality. This air can sometimes be cooler than your desired indoor temperature. This is normal.

My house is too hot

- 1 SmartVent systems are designed to provide ventilation to the home. Being able to cool the home down to a comfortable temperature in extreme temperatures is not guaranteed.

The scheduler is not switching at the right time

- 1 The system has up to a 5 minute delay between switching states.
- 2 Check that your system clock time is correct. The system clock needs to be updated manually when daylight saving begins and ends.

Maintenance

Filter Replacement

The filter will require replacing when the ERROR CODE **FILE** is displayed.

- When replacing with a filter of the same type, go to FILTER RESET (setting 019) to reset the filter.
- Contact SmartVent on 0800 140 150 for more information on the other filter types available and the replacement of your current filter type if required.
- The **FILE** alert will still be displayed if the filter is not installed correctly.

FILTER TYPE	PRODUCT CODE	TYPICAL LIFE
F7	FAN2093	12 months
F7 Carbon	FAN2277	6 months
HEPA Carbon	FAN2278	6 months

Technical Specifications

TOUCH SCREEN CONTROLLER V3.7	
Temperature Range	5-35°C adjustable
Display Resolution	0.1°C
Operating Voltage/Frequency	220-240V AC, 50Hz
Switching Voltage	240V AC Max
Switching Current	3A max resistive load
Sensing Element	NTC thermistor
Operating Temperature	0 to 40°C
Operating Humidity	5-90% non condensing
Live Output Isolation	Relay
Output Control	Relay / 0-10V DC
Display	3.5" digital LCD touch screen
Approval	All relevant AS/NZS standards
EMC Approval	All relevant AS/NZS standards  E6337

Specifications are subject to change without notice

Contact: 0800 140 150
enquiry@smartvent.co.nz



Distributed by Simx Limited
PO Box 14347, Panmure, Auckland, New Zealand.
Technical Support (09) 259 1662 | e: sales@simx.co.nz | w: www.simx.co.nz

PUB1635 2011